

**A** = with ring – avec bague – mit Ring – con arillo – med ring

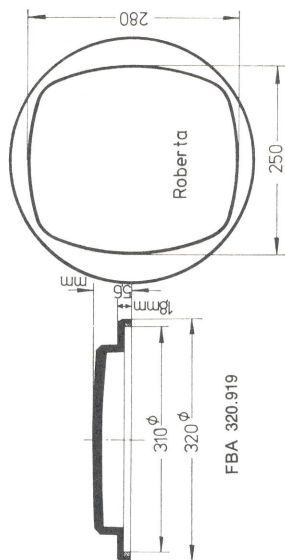

FB ↓

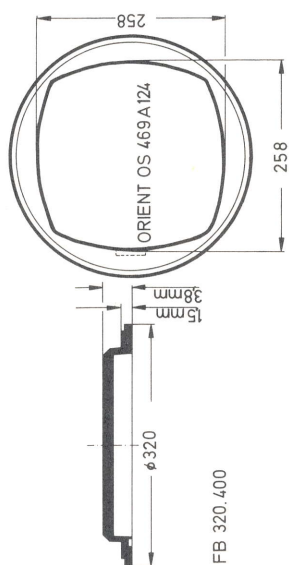
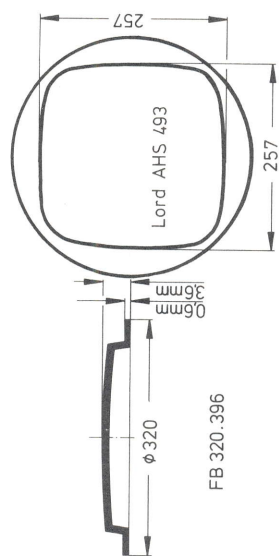
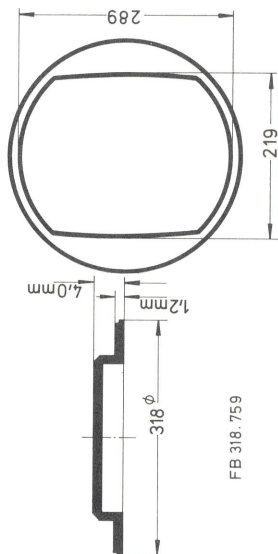
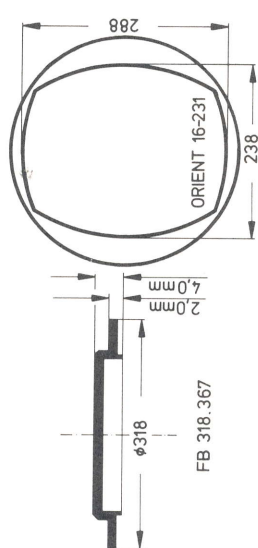
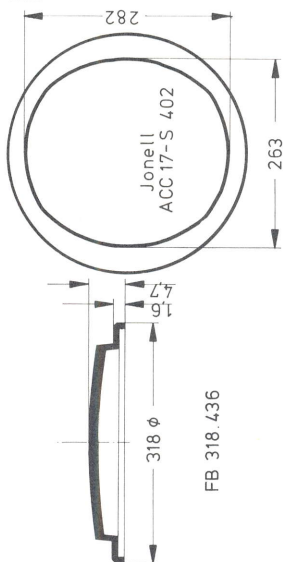

↓

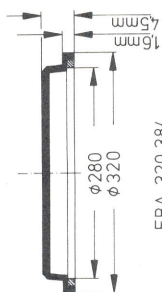
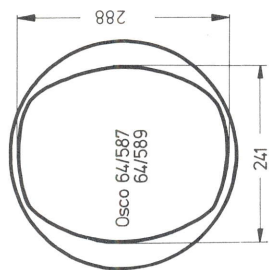

FBA 320.384

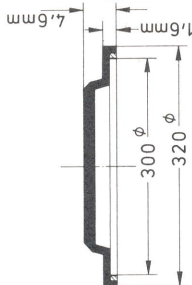
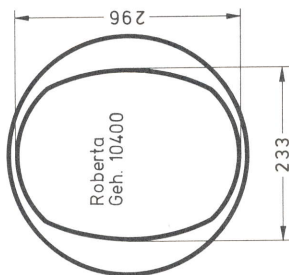

FBA 320.972

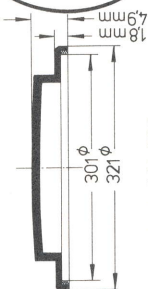
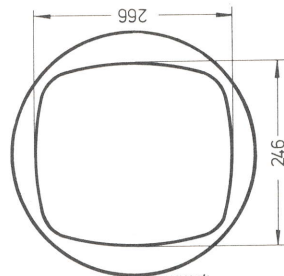

FBA 321.723

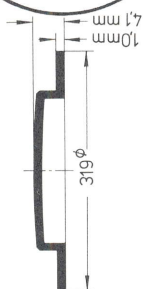
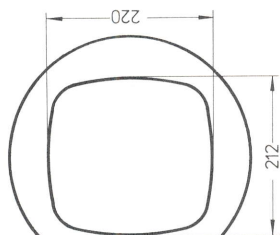

FB 319.918

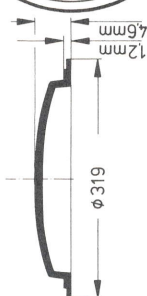
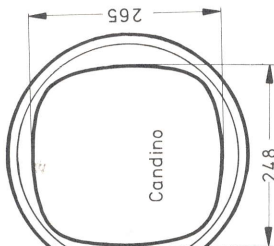

FB 319.393

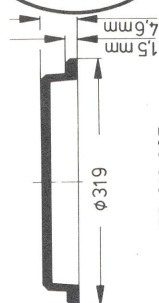
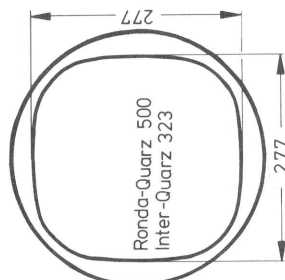

FB 319.397

**A** = with ring – avec bague – mit Ring – con arillo – med ring

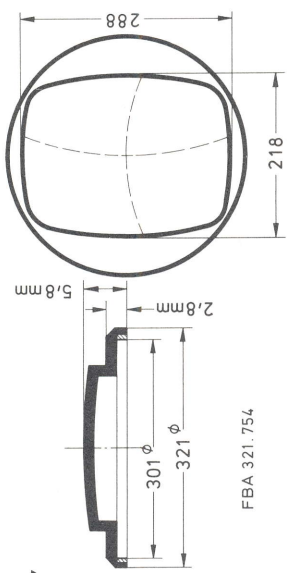

FBA 321.754

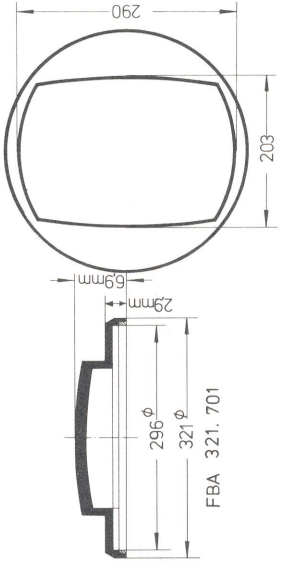

FBA 321.701

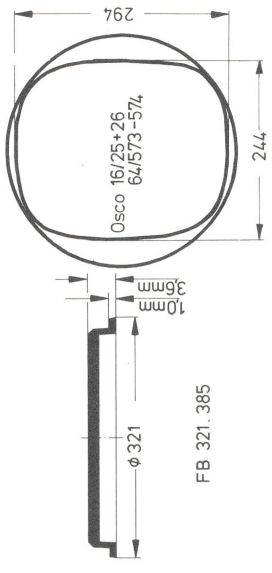

FB 321.385

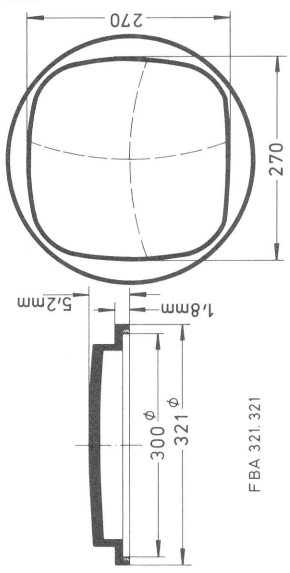

FBA 321.321

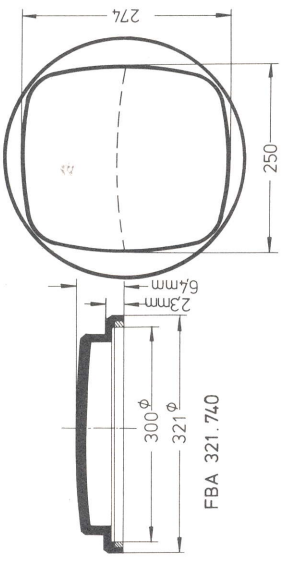

FBA 321.740

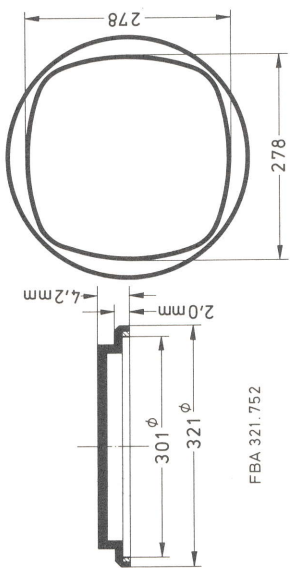

FBA 321.752

FB ↓

↑

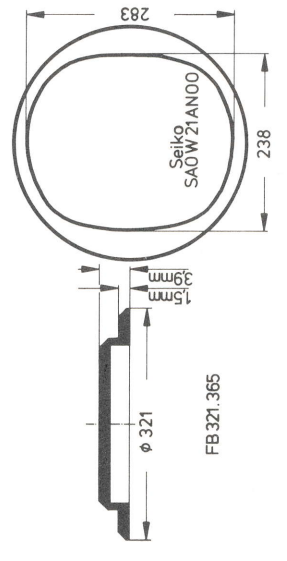
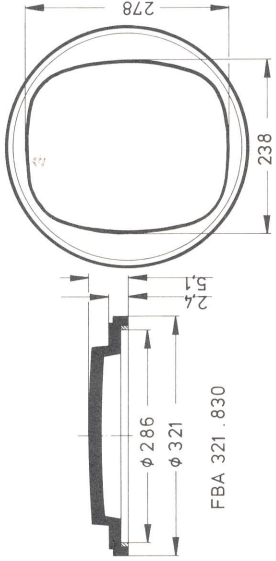
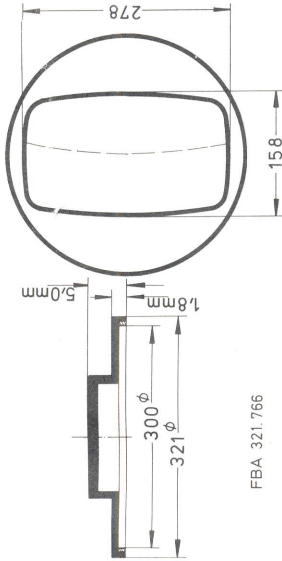
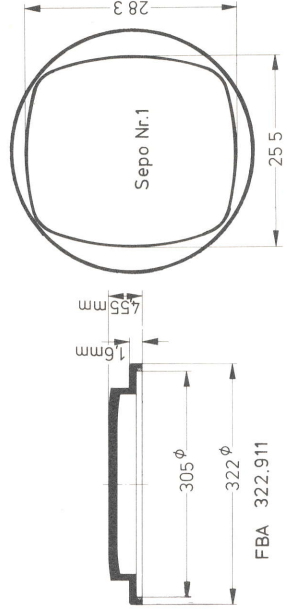
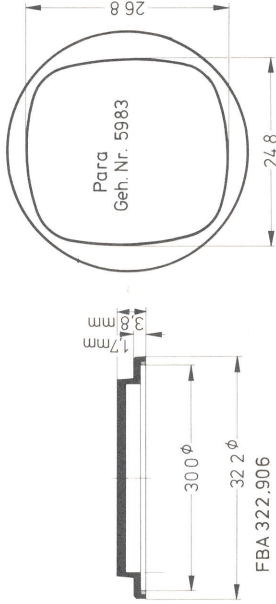
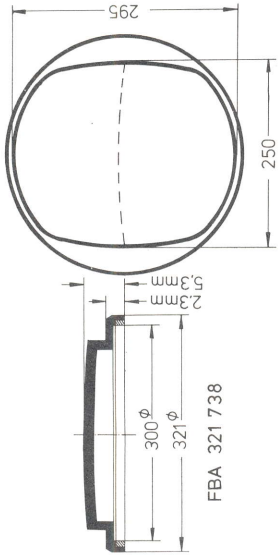

**A** = with ring – avec bague – mit Ring – con arillo – med ring

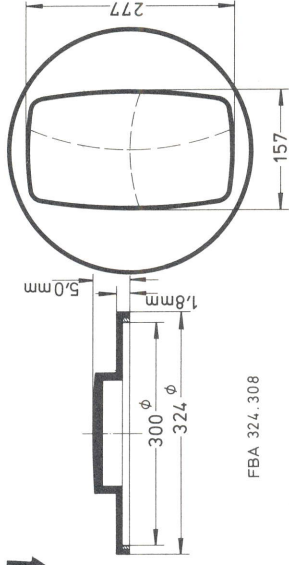

FBA 324.308

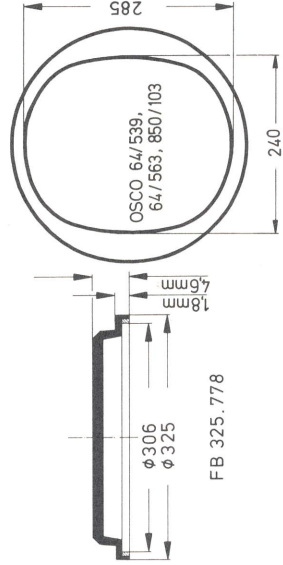

FB 325.778

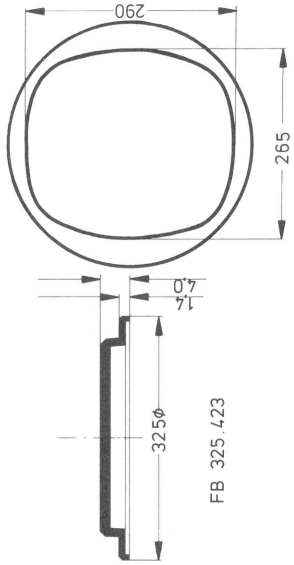

FB 325.423

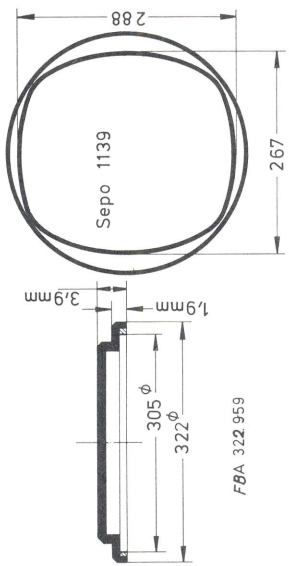

FBA 322.959

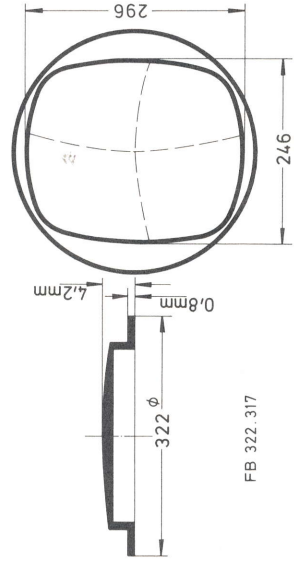

FB 322.317

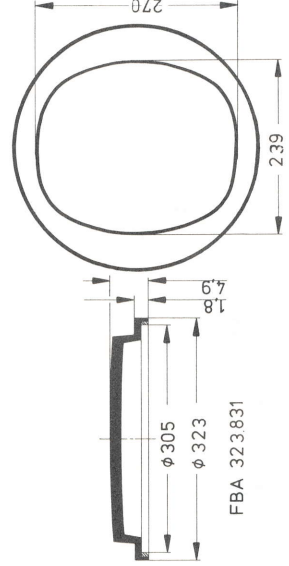

FBA 323.831

FB ↓

↓

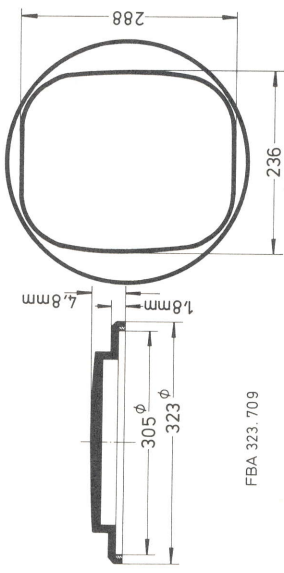
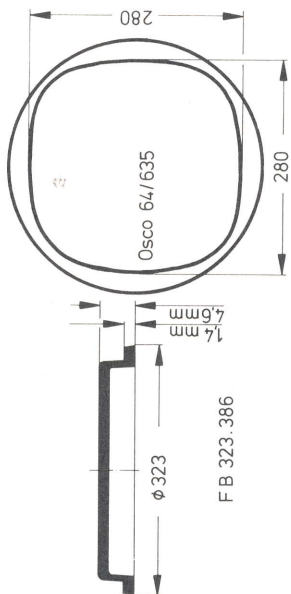
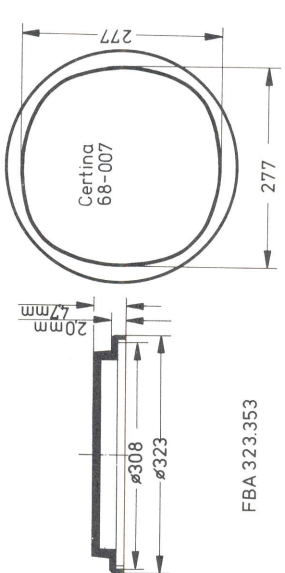
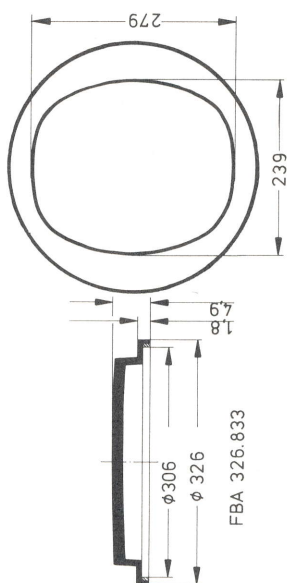
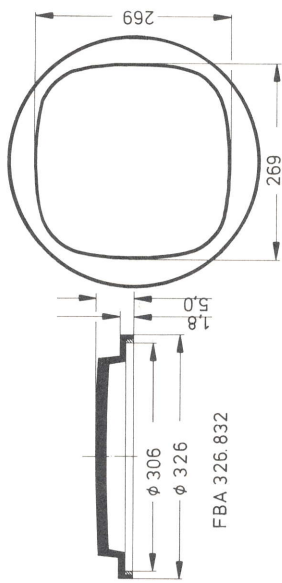
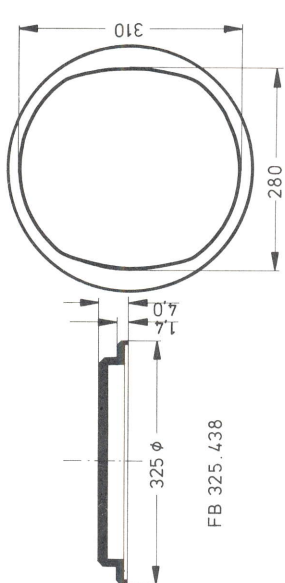

Certina  
68-007

Osco 64/635

**A** = with ring – avec bague – mit Ring – con arillo – med ring

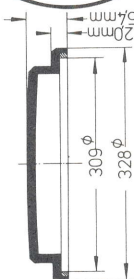
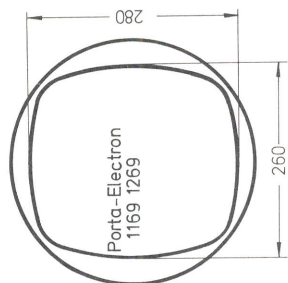

FBA 328.931

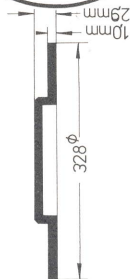
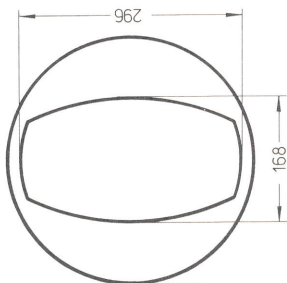

FB 328.925

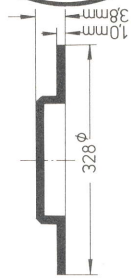
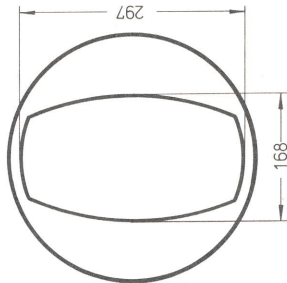

FB 328.935

FB ↓

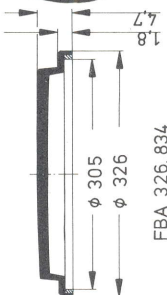
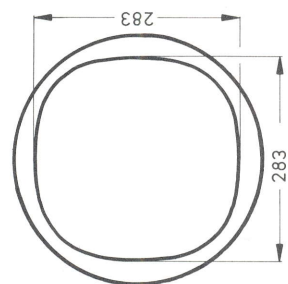

FBA 326.834

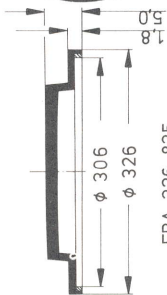
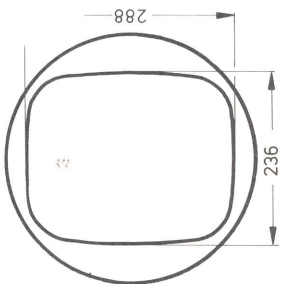

FBA 326.835

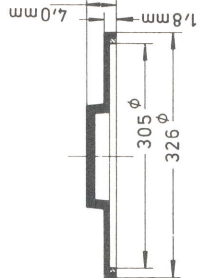
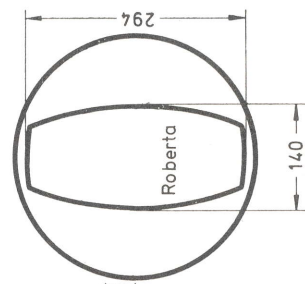

FB 326.961





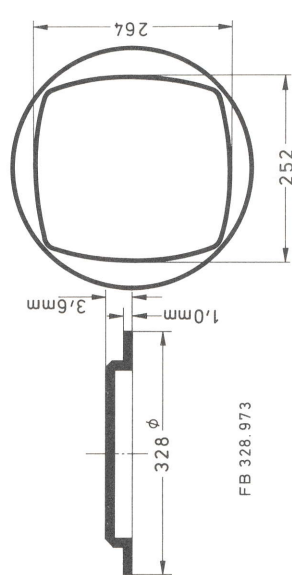
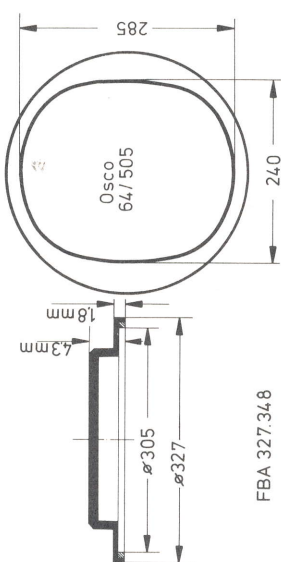
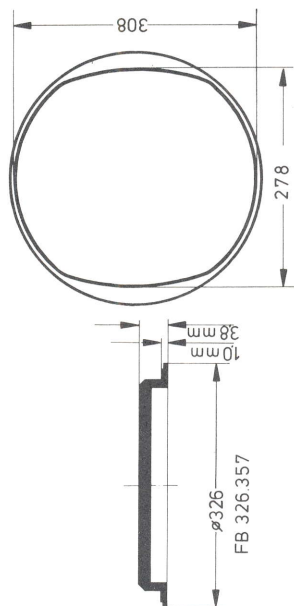
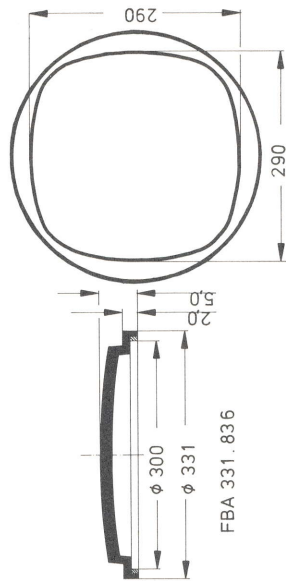
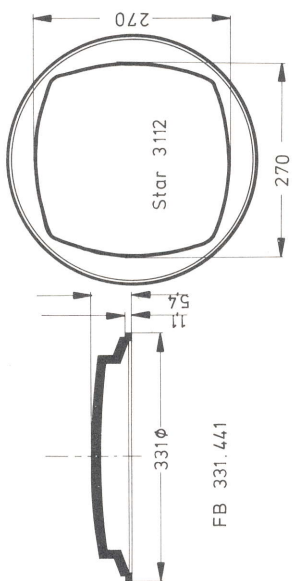
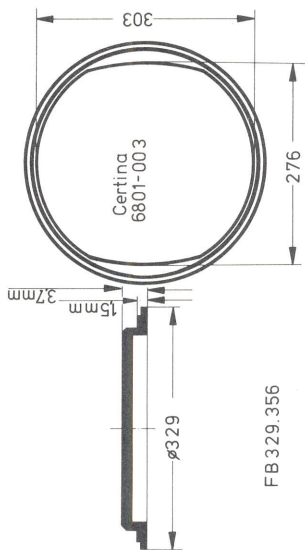

**A** = with ring – avec bague – mit Ring – con arillo – med ring

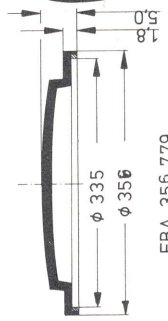
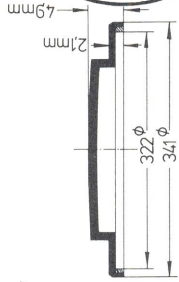
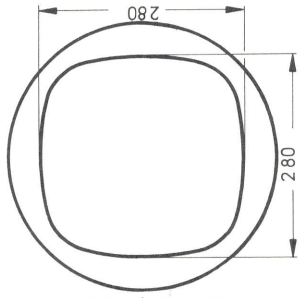
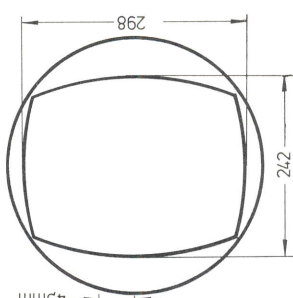

FBA 341.730

FBA 356.779

FB↓

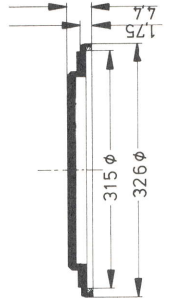
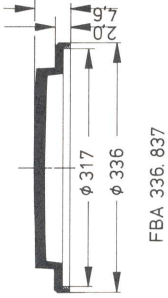
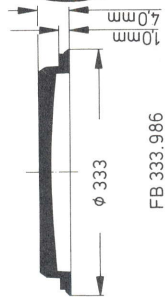
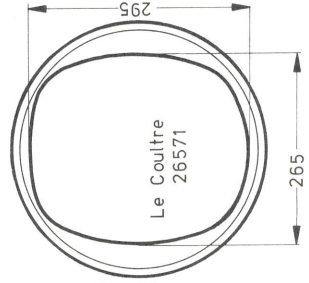
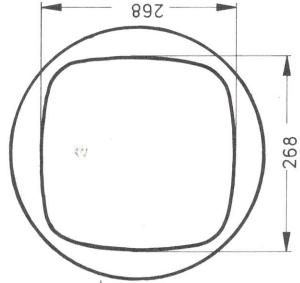
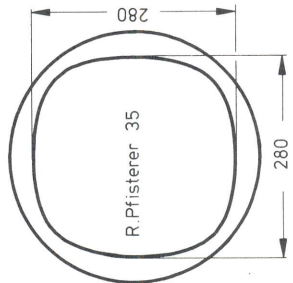

FBA 333.986

FBA 336.837

FBA 336.401

↓



FE ↓

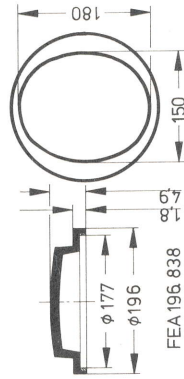
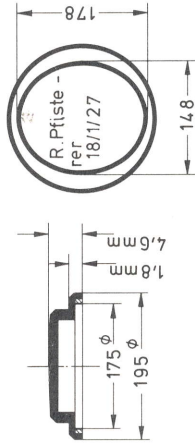
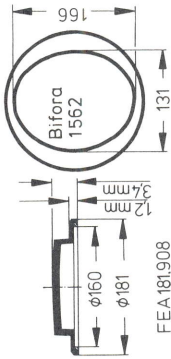
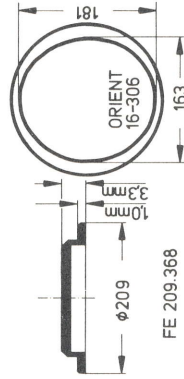
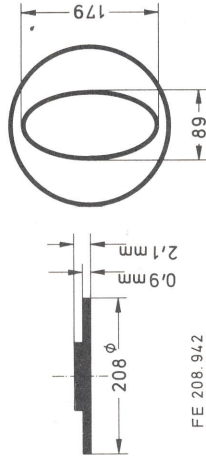
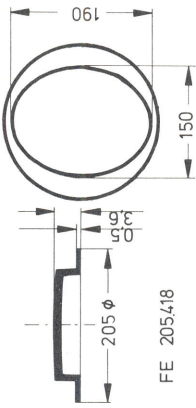

A = with ring – avec bague – mit Ring – con arillo – med ring

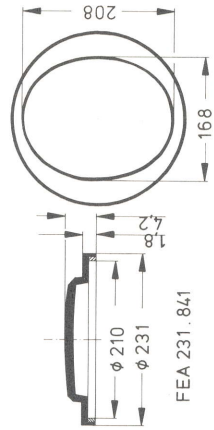
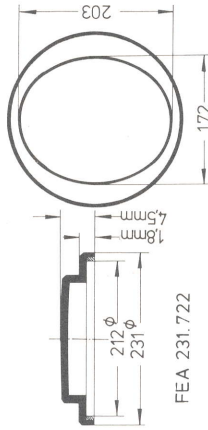
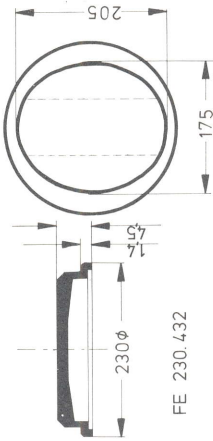

FE ↓

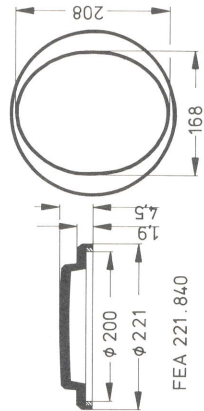
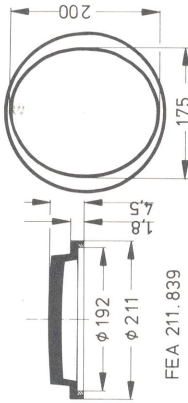
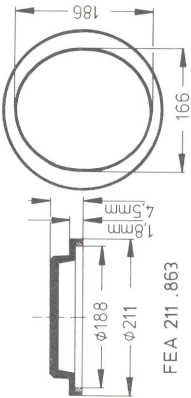

→

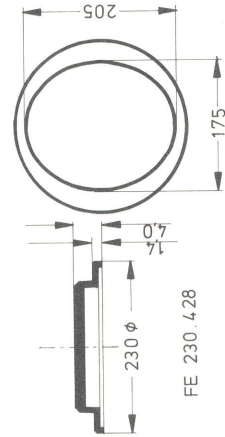
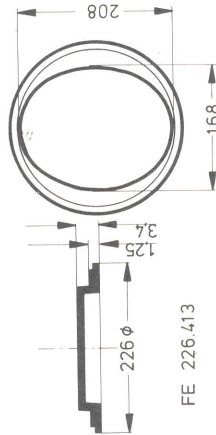
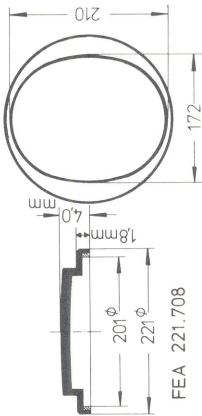
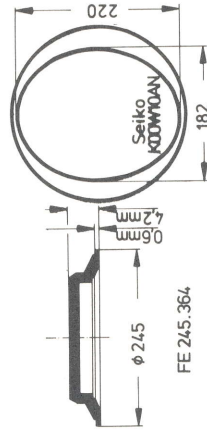
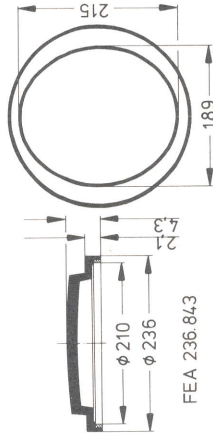
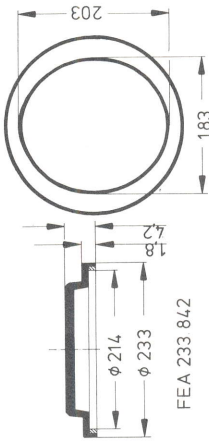

**A** = with ring – avec bague – mit Ring – con arillo – med ring

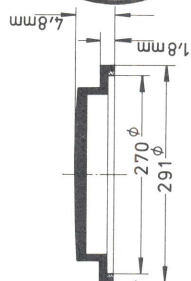
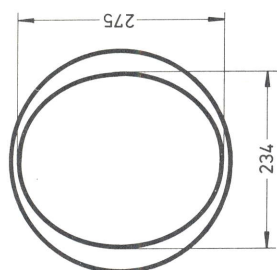

FEA 291.763

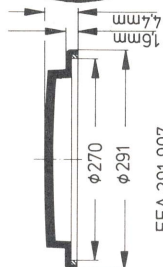
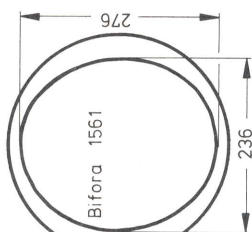

FEA 291.907

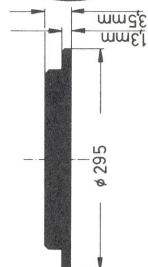
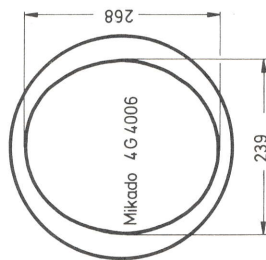

FEA 295.446

FE ↓

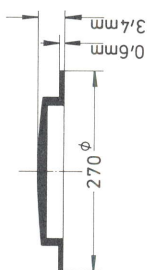
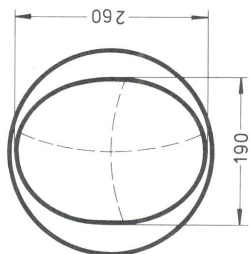

FEA 270.323

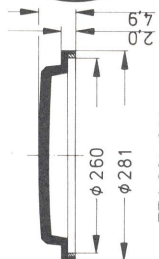
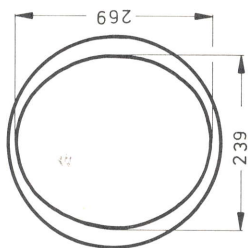

FEA 281.844

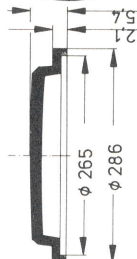
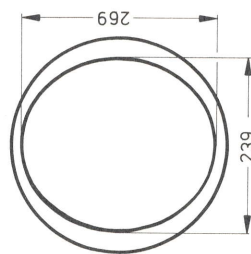

FEA 286.845

→

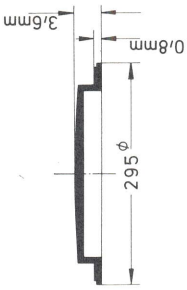
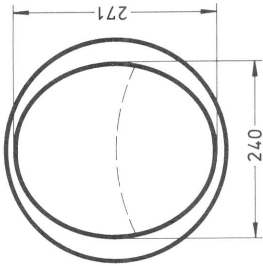

FE 295.313

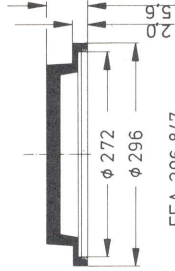
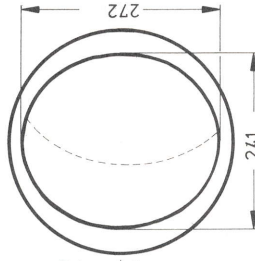

FEA 296.847

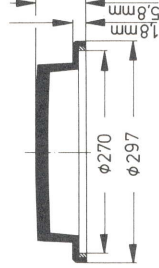
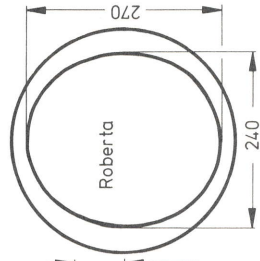

FEA 297.901

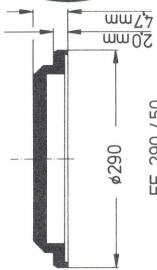
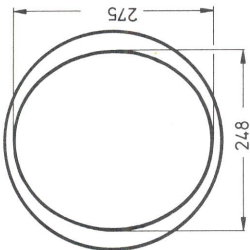

FE 290.450

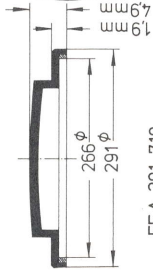
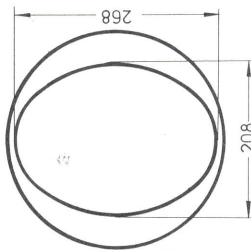

FEA 291.710

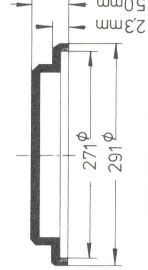
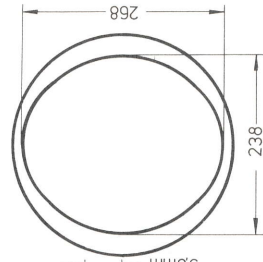

FEA 291.734

**A** = with ring – avec bague – mit Ring – con arillo – med ring

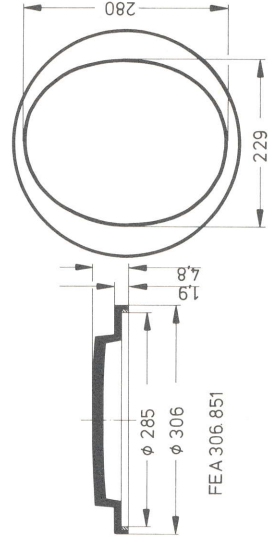
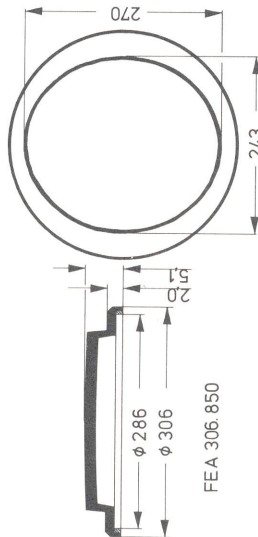
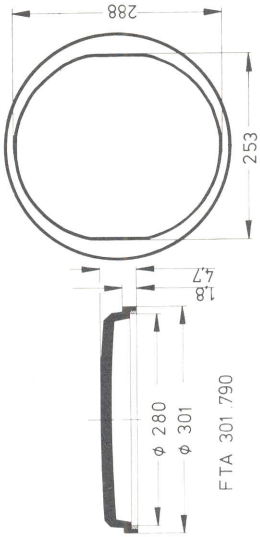

FE ↓

